

AMERICAN
TECHNICAL
CERAMICS

SINGLE LAYER CAPACITOR PRODUCTS



 THE
ENGINEERS'
CHOICE®



ISO 9001
REGISTERED
COMPANY

NEW ATC SLC QUIK PICK SELECTION GUIDE

The table below lists ATC SLC products available for **immediate shipment**. There is a **100 piece cap pac minimum order** per value. To order smaller quantities, please see Custom SLC Custom Design Kits, page 15.

SLC Selection Guide – Quik Pick 48 Hour Shipment®

Series / Case Size (L & W)		116 R .015 (.381) nom.	116 T .025 (.635) nom.	116 U .035 (.889) nom.	116 X .050 (1.27) nom.
Cap (pF)	Cap Code	0.1 to 100 pF	0.2 to 330 pF	0.4 to 820 pF	0.8 to 1000 pF
0.1	0R1	116RA0R1A100TT			
0.2	0R2	116RBB0R2A100TT	116TA0R2A100TT		
0.3	0R3	116RBB0R3A100TT	116TA0R3A100TT		
0.4	0R4	116RCA0R4B100TT	116TA0R4A100TT	116UA0R4A100TT	
0.5	0R5	116RCA0R5B100TT	116TBB0R5A100TT	116UA0R5A100TT	
0.8	0R8	116RDB0R8B100TT	116TBB0R8B100TT	116UBB0R8A100TT	116XA0R8A100TT
1.0	1R0	116RDB1R0C100TT	116TCA1R0B100TT	116UBB1R0B100TT	116XA1R0A100TT
1.2	1R2	116RDB1R2C100TT	116TCA1R2B100TT	116UBB1R2B100TT	116XA1R2A100TT
2.7	2R7	116REA2R7M100TT	116TDB2R7C100TT	116UCA2R7C100TT	116XBB2R7C100TT
3	3R0	116REA3R0M100TT	116TDB3R0C100TT	116UCA3R0C100TT	116XBB3R0C100TT
3.6	3R6	116REA3R6M100TT	116TDB3R6D100TT	116UCA3R6D100TT	116XCA3R6C100TT
5.1	5R1	116REA5R1M100TT	116TDB5R1D100TT	116UDB5R1D100TT	116XCA5R1C100TT
10	100	116RF100M100TT	116TEA100K100TT	116UDB100K100TT	116XDB100J100TT
15	150	116RF150M100TT	116TEA150K100TT	116UEA150K100TT	116XDB150J100TT
22	220	116RGA220M100TT	116TEA220K100TT	116UEA220K100TT	116XDB220K100TT
27	270	116RGA270M100TT	116TF270K100TT	116UEA270K100TT	116XDB270K100TT
33	330	116RGA330M100TT	116TF330K100TT	116UEA330K100TT	116XEA330K100TT
47	470	116RG470M100TT	116TF470K100TT	116UF470K100TT	116XEA470K100TT
56	560	116RG560M100TT	116TF560K100TT	116UF560K100TT	116XEA560K100TT
68	680	116RK680M100TT	116TGA680K100TT	116UF680K100TT	116XEA680K100TT
82	820	116RK820M100TT	116TGA820K100TT	116UF820K100TT	116XEA820K100TT
100	101	116RL101M100TT	116TGA101K100TT	116UF101K100TT	116XF101K100TT
220	221		116TK221M100TT	116UG221M100TT	116XF221K100TT
330	331		116TL331M100TT	116UK331M100TT	116XGA331K100TT
470	471			116UK471M100TT	116XGA471K100TT
560	561			116UL561M100TT	116XG561M100TT
680	681			116UL681M100TT	116XK681M100TT
820	821			116UL821M100TT	116XK821M100TT
1000	102				116XK102M100TT

Inches (mm)

ATC Part Number Code



Capacitance Tolerances

Code	A (pF)	B (pF)	C (pF)	D (pF)	F (%)	G (%)	J (%)	K (%)	M (%)
Tol.	± 0.05	± 0.1	± 0.25	± 0.5	± 1	± 2%	± 5	± 10	± 20%

The above part number refers to a 116 series, case size X, A dielectric, 1.2 pF, with a capacitance tolerance of A (±0.05pF), 100 WVDC, with thin film gold termination.

ATC accepts orders for our parts using designations with or without the "ATC" prefix. Both methods of defining the part number are equivalent, i.e., part numbers referenced with the "ATC" prefix are interchangeable to parts referenced without the "ATC" prefix. Customers are free to use either in specifying or procuring parts from American Technical Ceramics.

A M E R I C A N T E C H N I C A L C E R A M I C S

ATC North America +1-631-622-4700 • sales@atceramics.com
ATC Europe +46 8 6800410 • sales@atceramics-europe.com
ATC Asia +86-755-2396-8759 • sales@atceramics-asia.com

w w w . a t c e r a m i c s . c o m

TABLE OF CONTENTS

Introduction and General Specifications	2 - 7
Introduction	2 - 3
General Specifications	4 - 5
Dielectric and Typical TCC Data	6 - 7
Individual Product Descriptions	8 - 14
Straight Sided Microcap® - ATC 116 Series	8
ATC 116 Series MAX-K™ SLCs	9
Beveled Microcap® - ATC 111 Series	10
Single Sided Border Cap™ - ATC 118 Series	11
TWIN/CAP® SLC - ATC 113 Series	12
Multicap™ Custom Capacitor Arrays- ATC 117 Series	13
SLC Custom Design Kits	14
ATC SLC High Reliability Certification (COTS) Program	15
Contact Information	16



Front Cover:

Circuit images, top to bottom:

- 1) FET Amplifier, 10 to 16 GHz for optical transmitter application – *courtesy of Frequency Electronics, Inc. (FEI)*
- 2) Pin Attenuator, 6 to 12 GHz – *courtesy of American Microwave*
- 3) DRO, 6.5 to 8.8 GHz – *courtesy of Miteq*

End product application images:

- 1) Cassini Mission “ Saturn Orbiter and Titan Probe Spacecraft” – *courtesy of NASA*
- 2) U.S. Air Force E-3 Sentry Airborne Warning and Control System (AWACS) – *courtesy of DefenseLINK*

A M E R I C A N T E C H N I C A L C E R A M I C S

ATC North America **ATC Europe** **ATC Asia**
 +1-631-622-4700 • sales@atceramics.com +46 8 6800410 • sales@atceramics-europe.com +86-755-2396-8759 • sales@atceramics-asia.com

w w w . a t c e r a m i c s . c o m

Corporate Profile

American Technical Ceramics Corp. (ATC) provides component and custom integrated packaging solutions for the RF, microwave and telecommunications industries. For over forty years we have been "The Engineer's Choice®".

ATC designs, develops, manufactures and markets Multilayer Capacitors, Single Layer Capacitors, Resistor Products, Inductors and Custom Thin Film Products for RF, microwave and millimeter-wave applications. Our products are primarily used in: wireless communications infrastructure, fiber optics, medical electronics, semiconductor manufacturing equipment, defense, aerospace, and satellite communications markets.

As part of our globalization initiative ATC has a wholly-owned subsidiary for European Direct Sales, Applications Support and Distribution, located in Kungens Kurva, Sweden. The Company's wholly-owned subsidiary offering Technical Support for Asia is located in Shenzhen, P.R. China. ATC also has local offices in Holzkirchen, Germany and Guildford, England.

RLC Products

- Multilayer Ceramic Capacitors
- Capacitor Assemblies for Power Applications
- Single Layer Ceramic Capacitors
- Resistor Products
- Inductor Products

Process and Packaging

- Thin Film Custom Products: metalization and patterned substrates for a broad range of hybrid circuit requirements

Markets Served

- Wireless / Telecom Base Stations
- Semiconductor Manufacturing Equipment
- Medical Diagnostic Equipment
- Sattelite Systems
- Public Safety Radio
- Avionic Systems
- Military and Aerospace
- Commerical Broadcast Transmitters
- Fiber Optic Communications
- Automotive Electronics

Facilities

- Huntington Station, New York – Sales, Applications Support, Manufacturing and Distribution Center
- Kungens Kurva, Sweden – European Operations and Distribution Center
- Jacksonville, Florida – Advanced Technology Center, Manufacturing Facility

ATC's Quick Reference Product Selection Guide is designed to help you navigate through our products and services. The following parameters, included in ATC's complete catalog, are highlights of each Product Series:

- Full electrical and mechanical specifications
- ESR, FSR, Q and TCC Performance Curves
- Power Handling Data
- Design Software
- Application Notes
- Thin Film Overview



▲ *Advanced Technology Center, Manufacturing Facility, Jacksonville, Florida*



▶ *Autopacking center packages chips into waffle packs*

A M E R I C A N T E C H N I C A L C E R A M I C S

ATC North America

+1-631-622-4700 • sales@atceramics.com

ATC Europe

+46 8 6800410 • sales@atceramics-europe.com

ATC Asia

+86-755-2396-8759 • sales@atceramics-asia.com

w w w . a t c e r a m i c s . c o m

INTRODUCTION

ATC's extensive line of Single Layer Capacitor (SLC) products offers solutions to the most demanding microwave and millimeter wave requirements. Broadband applications with operating frequencies up to 100 GHz are achievable with ATC's SLC products. With an extensive range of dielectrics, capacitance values from 0.04 pF to 10,000 pF are available. Dielectric constants from 14 to 25,000 are available in standard case sizes from 10 mils. ATC also offers a "design your own" option to facilitate specific outline dimensions to meet exact circuit trace width matching requirements. ATC's single layer products are derived from the highest quality materials that result in ultra high Q and reliable performance. All SLC products have a voltage rating of up to 100 WVDC. All ATC Design and Manufacturing facilities are certified to ISO9000 quality standards.

The following pages of this catalog contain a broad listing of ATC's standard single layer capacitors. The catalog provides an overview of general single layer product specifications and ceramic capacitor dielectrics as well as a more detailed description of each product group, listing case sizes, capacitance values, and available tolerances. ATC standard single layer capacitors are listed in order of ascending dielectric constant per the size and capacitance value available. Available capacitance tolerances are listed. For non-EIA capacitor values or sizes not shown in this catalog, please contact the Factory and our Engineering Design Support Group will be glad to assist in any way possible.



◀ *Niro Spray Dryer - Spray drying is a unique drying process involving both particle formation and drying*



▲ *Spin Coat - Applying positive photoresist via spin coating*

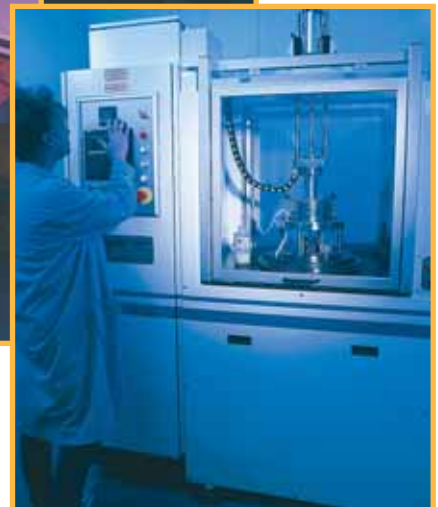

LSP6 - Dual Plate Lapping Machine ▶

AMERICAN TECHNICAL CERAMICS

ATC North America ATC Europe ATC Asia
+1-631-622-4700 • sales@atceramics.com +46 8 6800410 • sales@atceramics-europe.com +86-755-2396-8759 • sales@atceramics-asia.com

w w w . a t c e r a m i c s . c o m

GENERAL SPECIFICATIONS



Features

- Broadband applications up to 100 GHz
- Rugged construction
- Ultra-high Q
- Standard capacitance range 0.04 to 10,000 pF
- Dielectric constants from 14 to 25,000
- Voltage ratings up to 100 WVDC
- Low cost
- All SLC products are RoHS compliant

Electrical Characteristics

Operating Frequency:	Up to 100 GHz
Resonant Frequency:	See curve
Insulation Resistance:	1×10^{11} Ohms min @ +25°C and rated voltage
Voltage Rating:	Up to 100 WVDC (for higher ratings, contact factory)
Dielectric Test Voltage:	250% of voltage rating for 5 seconds Impervious to static discharge

Mechanical Characteristics

Resistance to Solvents: ATC's dielectrics are virtually unaffected by moisture and commonly used cleaning solvents.

Bond Strength: All terminations meet or exceed MIL-STD-883 Method 2019 for Die Shear Strength. Wire bondability meets or exceeds ML-C-49464 Para. 3.12 and MIL-STD-883 Method 2011.

Inspection ►

Termination

TT: Thin Film Gold (Standard) Titanium Tungsten/Nickel/Gold (100 μ -inches Gold Finish minimum.) Contact ATC for alternate termination styles.

Environmental Characteristics

Operating Temperature: Refer to TCC data on pages 6 and 7 for temperature limits.

Additional Environmental Characteristics:

ATC Capacitors are designed and manufactured to meet or exceed the environmental limits as defined in MIL-C-49464.

Series Resonance vs Capacitance for Minimum Thickness

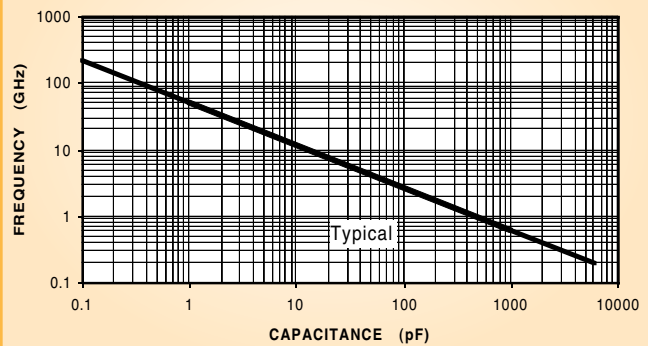

A M E R I C A N T E C H N I C A L C E R A M I C S

ATC North America

+1-631-622-4700 • sales@atceramics.com

ATC Europe

+46 8 6800410 • sales@atceramics-europe.com

ATC Asia

+86-755-2396-8759 • sales@atceramics-asia.com

w w w . a t c e r a m i c s . c o m

GENERAL SPECIFICATIONS

Quality Program

Stringent process procedures and exacting material requirements ensure that only the highest quality parts are shipped. ATC's manufacturing and Quality Testing facilities comply with the following specifications:

- ISO 10012-1 Quality Assurance for Measuring Equipment
- ISO 9001 qualified facility
- ANSI / NCSL Z540-1-1994 Calibration Laboratories and Measuring and Test Equipment - General Requirements

Qualification Testing

ATC's Microcap® products are designed and manufactured to meet or exceed the following requirements as detailed in MIL-STD-202 and MIL-C-49464:

- Immersion (MIL-STD-202 meth. 104)
- Resistance to solder heat (MIL-STD-202 meth. 210)
- Moisture resistance (MIL-STD-202 meth. 106)
- Life Test (MIL-STD-202 meth. 108, cond. F) +125°C at 2x Rated Voltage.
- Solderability (MIL-STD-202 meth. 208)
- Voltage Conditioning (MIL-STD-202 meth. 108, cond. A) +125°C at 2X Rated Voltage.
- Low voltage humidity (MIL-C-49464)

High Reliability Certification Program

For enhanced reliability applications, ATC's Commercial Off The Shelf (COTS) High Reliability Program is available for single layer capacitors. See Page 15 for a full program description.



Custom Designs

Custom Sizes: ATC internally manufactures substrates for the Microcap® product line. As such ATC can accommodate virtually any size or thickness single layer capacitor. Contact ATC to discuss your specific requirements

For higher capacitance values and voltage, consult factory.

Dimension Guidelines

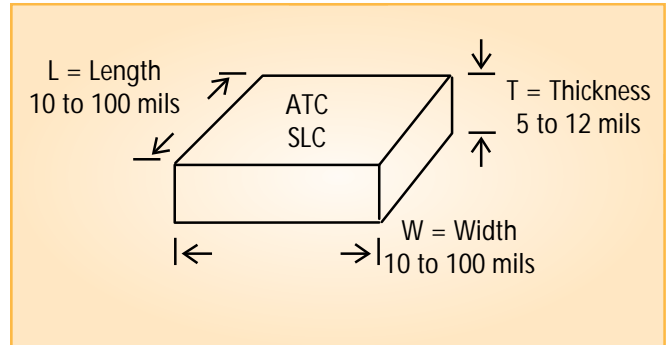

Design Your Own Single Layer Capacitor

ATC gives you the ability to create custom values and dimensions. When circuit board area is tight or you need to match your stripline width, you can optimize the size and shape of required SLCs. This same technique can be used to build special values that fall outside of the standard offerings.

Design Guidelines

$$C = \text{Capacitance (pF)} \quad C = \frac{(.225 \text{ K} \times L \times W)}{(1000 \times T)}$$

L = Length 10 to 100 mils

W = Width 10 to 100 mils

T = Thickness 5 to 12 mils, less than or equal to
L/2 or W/2

Custom Values and Sizes

Optimize the best combination of length, width, thickness and dielectric material for your circuit/stripline capacitor requirements.

A M E R I C A N T E C H N I C A L C E R A M I C S

ATC North America ATC Europe ATC Asia
+1-631-622-4700 • sales@atceramics.com +46 8 6800410 • sales@atceramics-europe.com +86-755-2396-8759 • sales@atceramics-asia.com

w w w . a t c e r a m i c s . c o m

Stable K Dielectrics

Dielectric Code	Dielectric Const. (K)	TCC (-55°C to +125°C)	Cap. Range (pF)	Max. DF @ 1 MHz (%)	Q
A	14	+90 ±30 PPM/°C	0.04 to 5.6	0.01	11,000 @ 6.4 GHz
BB	31	0 ±30 PPM/°C	0.06 to 13	0.15	950 @ 4.5 GHz
CA	60	0 ±30 PPM/°C	0.1 to 27	0.15	770 @ 5 GHz

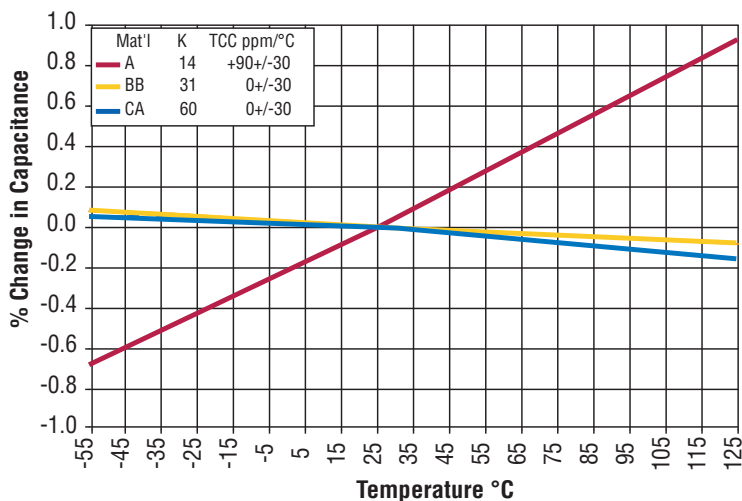

Mid-K Dielectrics

Dielectric Code	Dielectric Const. (K)	TCC (-55°C to +125°C)	Cap. Range (pF)	Max. DF (%)*		Q
				@ 1 MHz	@ 1 KHz	
CC	130	-750 ±200 PPM/°C	0.3 to 56	0.15	-	2310 @ 5 GHz
DA	165	-1500 ±500 PPM/°C	0.4 to 68	0.25	-	500 @ 1.8 GHz
DB	200	±7.5% max. change (non-linear)	0.5 to 82	0.25	-	29 @ 5 GHz
HC	420	-2000 ±500 PPM/°C	1.1 to 180	0.7	0.3	-
EA	650	-4700 ±1500 PPM/°C	1.5 to 270	0.3	0.3	-

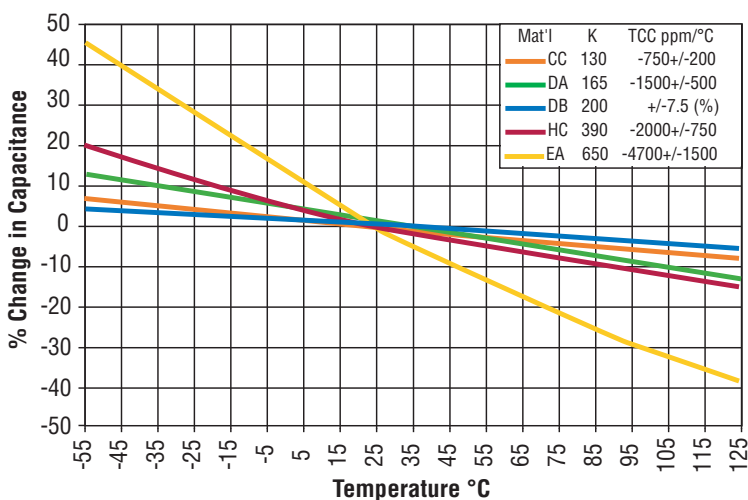

* Capacitance and DF are measured at 1 MHz for C ≤ 100 pF and 1 KHz for C > 100 pF.

- DF readings are not accurately measurable for capacitor values < 4.7 pF in all ceramic types.
- For products made with A Dielectric, DF readings are not accurately measurable for capacitor values < 10 pF.

A M E R I C A N T E C H N I C A L C E R A M I C S

ATC North America

ATC Europe

ATC Asia

+1-631-622-4700 • sales@atceramics.com +46 8 6800410 • sales@atceramics-europe.com +86-755-2396-8759 • sales@atceramics-asia.com

w w w . a t c e r a m i c s . c o m

High-K Dielectrics

Dielectric Code	Dielectric Const. (K)	TCC (-55°C to +125°C)	Cap. Range (pF)	Max. DF (%)*	
				@ 1 MHz	@ 1 KHz
EC	650	±10% max. change (non-linear)	1.5 to 270	1.5	1.5
J	1100	+5% to -15% max. change (non-linear)	2.4 to 470	2.5	2.0
F	2000	±15% max. change (non-linear)	4.3 to 820	2.5	2.0
GA	4000	±15%	10 to 1800	4.0**	2.0**

**DF is 6.5% max. for 118, 113 and 117 Series with Photoetched Process.

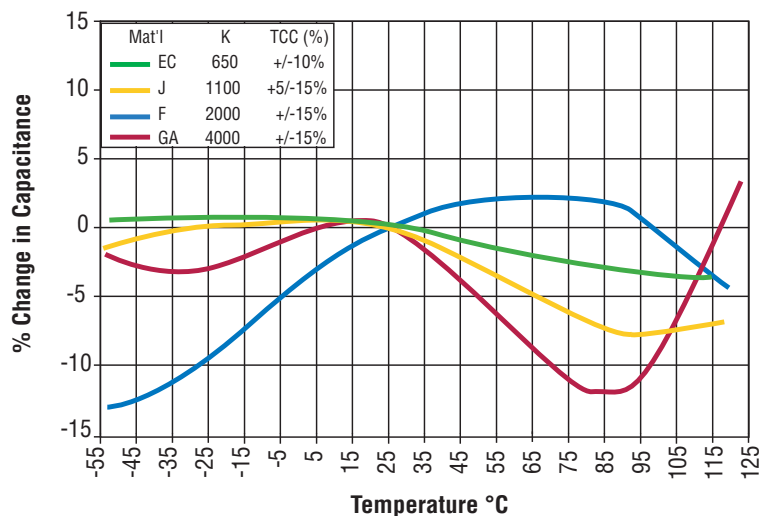

Ultra High-K Dielectrics

Dielectric Code	Dielectric Const. (K)	TCC (+10°C to +85°C)	Cap. Range (pF)	Max. DF (%)*	
				@ 1 MHz	@ 1 KHz
G	6000	+10% to -75% max. change (non-linear)	13 to 2400	2.5	2.0
K	9000	0% to -92% max. change (non linear)	20 to 3300	4.0	2.0
L	16,000	0/-92%	33 to 6200	3.5	2.0

NOTE: Dielectric Code M, with a dielectric constant of 25,000, is also available. See page 9.

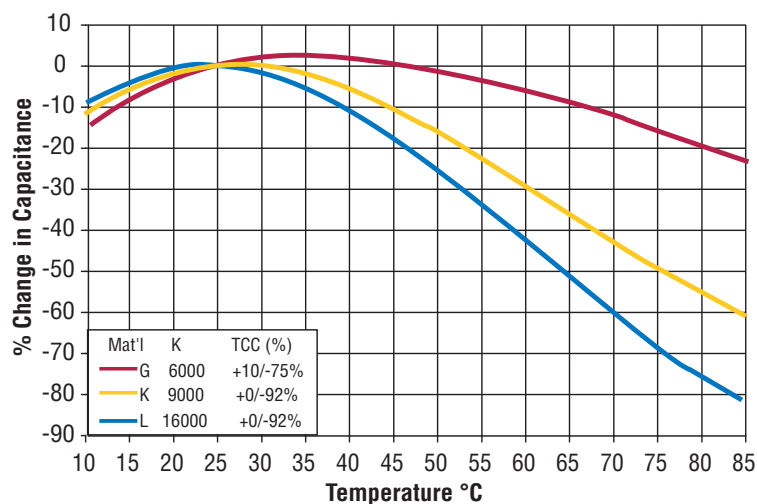

* Capacitance and DF are measured at 1 MHz for C ≤ 100 pF and 1 KHz for C > 100 pF.

- DF readings are not accurately measurable for capacitor values < 4.7 pF in all ceramic types.
- For products made with A Dielectric, DF readings are not accurately measurable for capacitor values < 10 pF.

A M E R I C A N T E C H N I C A L C E R A M I C S

ATC North America **ATC Europe** **ATC Asia**
 +1-631-622-4700 • sales@atceramics.com +46 8 6800410 • sales@atceramics-europe.com +86-755-2396-8759 • sales@atceramics-asia.com

w w w . a t c e r a m i c s . c o m

ATC 116 SERIES MICROCAPS®

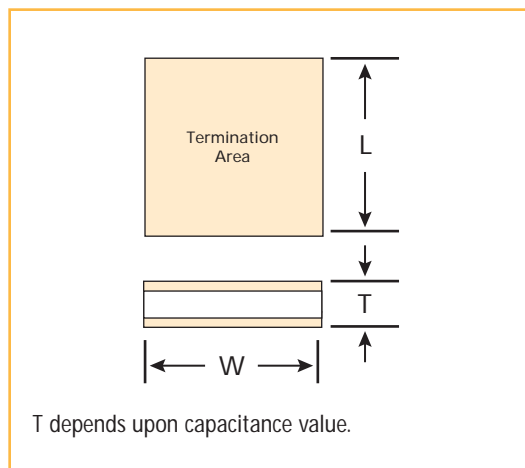

ATC 116 SERIES MICROCAP® – The 116 series SLC with a conventional straight-sided design offers the highest capacitance per outline size. This design allows the user to match line width or design a custom capacitor for limited circuit dimensions.

Selection Guide

Case Size	R			S			T			U			X			Y			Z			
Dimensions (L&W)	.015 (.381) ± .003 (.076)			.018 (.457) ± .003 (.076)			.025 (.635) ± .005 (.127)			.035 (.889) ± .005 (.127)			.050 (1.27) ± .010 (.254)			.070 (1.78) ± .010 (.254)			.090 (2.29) ± .010 (.254)			
Min. Thickness (T)	.0045 (.114)			.0045 (.114)			.0045 (.114)			.0045 (.114)			.0045 (.114)			.0045 (.114)			.0045 (.114)			
Max. Thickness (T)	.012 (.305)			.012 (.305)			.012 (.305)			.012 (.305)			.012 (.305)			.012 (.305)			.012 (.305)			
	Capacitance (pF)			Capacitance (pF)			Capacitance (pF)			Capacitance (pF)			Capacitance (pF)			Capacitance (pF)			Capacitance (pF)			
	Min.	Max.	Tol.	Min.	Max.	Tol.	Min.	Max.	Tol.	Min.	Max.	Tol.	Min.	Max.	Tol.	Min.	Max.	Tol.	Min.	Max.	Tol.	
Dielectric	K																					
A	14	0.06	0.2	A	0.08	0.2	A	0.2	0.4	A, B	0.4	0.9	A, B, C	0.6	2	A, B, C	1.3	3.9	A, B, C	2.2	5.6	A, B, C
BB	31	0.2	0.5	A, B	0.2	0.5	A, B	0.4	1	A, B, C	0.7	2	A, B, C, D	1.5	4.7	B, C, D	3	8.2	B, C, D	5.1	13	C, D
CA	60	0.3	1	B, C	0.4	1.1	A, B, C, D	0.8	2	B, C, D	1.5	3.9	B, C, D	2.7	9.1	C, D	6.2	16	D, G, J, K, M	10	27	G, J, K, M
CC	130	0.6	2	C, D	0.8	2.2	B, C, D	1.5	4.3	C, D	3	8.2	C, D	5.6	20	D, G, J, K, M	12	36	G, J, K, M	22	56	G, J, K, M
DA	165	0.7	2.7	C, D	1	2.7	C, D	2	5.6	C, D	3.9	11	D, J, K, M	6.8	24	D, G, J, K, M	15	43	G, J, K, M	27	68	G, J, K, M
DB	200	0.8	3.0	C, D	1.2	3.6	C, D	2.4	6.8	C, D	4.7	13	D, J, K, M	8.2	30	G, J, K, M	20	56	G, J, K, M	33	82	G, J, K, M
HC	420	1.5	5.6	D, K, M	2.2	6.2	D, J, K, M	4.3	12	D, J, K, M	8.2	22	J, K, M	15	51	G, J, K, M	33	91	G, J, K, M	56	150	G, J, K, M
EA	650	2.7	10	K, M	4.3	11	D, J, K, M	7.5	22	J, K, M	15	43	J, K, M	27	100	G, J, K, M	62	180	G, J, K, M	110	270	G, J, K, M
EC	650	2.7	10	K, M	4.3	11	D, J, K, M	7.5	22	J, K, M	15	43	J, K, M	27	100	G, J, K, M	62	180	G, J, K, M	110	270	G, J, K, M
J	1100	4.7	18	K, M	6.8	18	J, K, M	13	36	J, K, M	27	75	J, K, M	47	160	J, K, M	100	300	J, K, M	180	470	J, K, M
F	2000	8.2	33	K, M	13	36	J, K, M	24	68	J, K, M	47	130	J, K, M	82	300	J, K, M	220	560	J, K, M	330	820	J, K, M
GA	4000	18	68	K, M	30	75	J, K, M	56	150	J, K, M	110	300	J, K, M	180	680	J, K, M	430	1200	J, K, M	750	1800	J, K, M
G	6000	27	91	M	39	100	M	75	200	M	150	390	M	240	910	M	560	1600	M	1000	2400	M
K	9000	36	130	M	56	130	M	110	270	M	220	510	M	360	1200	M	910	2200	M	1500	3300	M
L	16000	62	220	M	91	270	M	180	510	M	390	1000	M	620	2200	M	1500	3900	M	2400	6200	M

Availability of above products may vary. See Quik Pick list on page inside front cover for stock items.

Inches (mm)

ATC Part Number Code

ATC Series: 116
 Case Size: X
 Dielectric Style: Max. 2 characters: A
 Capacitance Code: First 2 significant digits for capacitance. R=Decimal Point: 1R
 Indicates number of zeros following digits of capacitance in picofarads except for decimal values: 5
 Termination Code: Thin Film Gold (standard) Titanium Tungsten/Nickel/Gold (100 μ-inches gold finish minimum.) Contact ATC for alternate termination styles: B II
 WVDC (in Volts): 3 significant digits, 100 Volts is standard: 100
 Capacitance Tolerance (see table below): II

Capacitance Tolerances									
Code	A (pF)	B (pF)	C (pF)	D (pF)	F (%)	G (%)	J (%)	K (%)	M (%)
Tol.	± 0.05	± 0.1	± 0.25	± 0.5	± 1	± 2%	± 5	± 10	± 20%

The above part number refers to a 116 series, case size X, A dielectric, 1.5 pF, with a capacitance tolerance of B (±0.1pF), 100 WVDC, with thin film gold termination. ATC accepts orders for our parts using designations with or without the "ATC" prefix. Both methods of defining the part number are equivalent, i.e., part numbers referenced with the "ATC" prefix are interchangeable to parts referenced without the "ATC" prefix. Customers are free to use either in specifying or procuring parts from American Technical Ceramics.

AMERICAN TECHNICAL CERAMICS

ATC North America

+1-631-622-4700 • sales@atceramics.com

ATC Europe

+46 8 6800410 • sales@atceramics-europe.com

ATC Asia

+86-755-2396-8759 • sales@atceramics-asia.com

ATC 116 SERIES MAX-K™ M DIELECTRIC SLCs

ATC's 116 Series MAX-K™ single layer capacitors provide the highest capacitance per unit area with a stable X7R temperature coefficient of capacitance ($\pm 15\%$).

Features

- X7R Dielectric $\pm 15\%$ (-55 °C to +125 °C)
- Capacitance Range 150 to 10,000 pF
- Dielectric Constant 25,000 typ.

Specifications

- DF 2.5% max., measured at 1 KHz
- Insulation Resistance: 10^4 M Ω (typ.) @ 25°C
- Working Voltage: 50 WVDC
- Aging Rate: less than 3% per decade hour
- Bond Strength and Die Sheer: MIL-STD-883

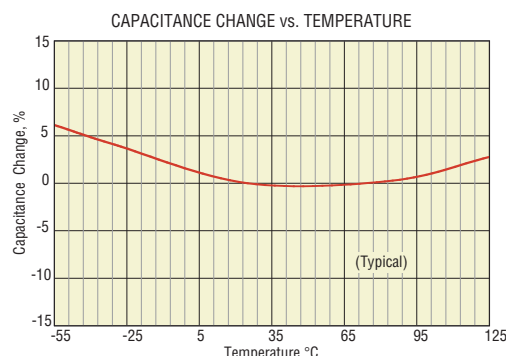

Selection Guide

Case Size	R	T	U	X	Y	Z
Dimensions (L&W nom.)	.015 (.381) $\pm .005$ (.127)	.025 (.635) $\pm .005$ (.127)	.035 (.889) $\pm .005$ (.127)	.050 (1.27) $\pm .010$ (.254)	.070 (1.78) $\pm .010$ (.254)	.090 (2.29) $\pm .010$ (.254)
50 V Thickness (T)	.007 (.178) + .002 (.051) - .001 (.025)	.007 (.178) + .002 (.051) - .001 (.025)	.007 (.178) + .002 (.051) - .001 (.025)	.007 (.178) + .002 (.051) - .001 (.025)	.007 (.178) + .002 (.051) - .001 (.025)	.007 (.178) + .002 (.051) - .001 (.025)
Cap (pF) Cap Code						
150 151	116RM151M050TT					
220 221	116RM221M050TT					
270 271	116RM271M050TT					
330 331	116RM331M050TT					
390 391		116TM391M050TT				
470 471		116TM471M050TT				
560 561		116TM561M050TT				
680 681		116TM681M050TT				
750 751		116TM751M050TT				
820 821		116TM821M050TT	116UM821M050TT			
1000 102			116UM102M050TT			
1200 122			116UM122M050TT			
1500 152			116UM152M050TT	116XM152M050TT		
1800 182				116XM182M050TT		
2200 222				116XM222M050TT		
2700 272				116XM272M050TT		
3300 332				116XM332M050TT	116YM332M050TT	
3900 392					116YM392M050TT	
4700 472					116YM472M050TT	
5600 562					116YM562M050TT	
6200 622					116YM622M050TT	116ZM622M050TT
6800 682					116YM682M050TT	116ZM682M050TT
7500 752						116ZM752M050TT
8200 822						116ZM822M050TT
10000 103						116ZM103M050TT

Prototype quantities available in 1 week. Custom sizes available upon request.

Inches (mm)

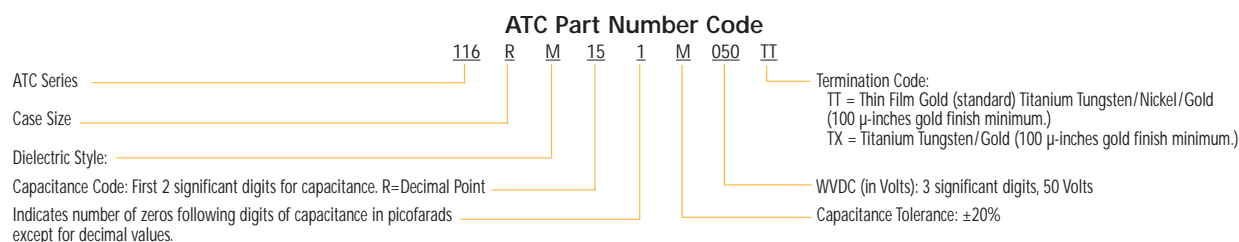

The above part number refers to a 116 series, case size R, M dielectric, 150 pF, with a capacitance tolerance of M ($\pm 20\%$), 50 WVDC, with thin film gold termination. ATC accepts orders for our parts using designations with or without the "ATC" prefix. Both methods of defining the part number are equivalent, i.e., part numbers referenced with the "ATC" prefix are interchangeable to parts referenced without the "ATC" prefix. Customers are free to use either in specifying or procuring parts from American Technical Ceramics.

A M E R I C A N T E C H N I C A L C E R A M I C S

ATC North America **ATC Europe** **ATC Asia**
 +1-631-622-4700 • sales@atceramics.com +46 8 6800410 • sales@atceramics-europe.com +86-755-2396-8759 • sales@atceramics-asia.com

w w w . a t c e r a m i c s . c o m

ATC 111 SERIES MICROCAPS®

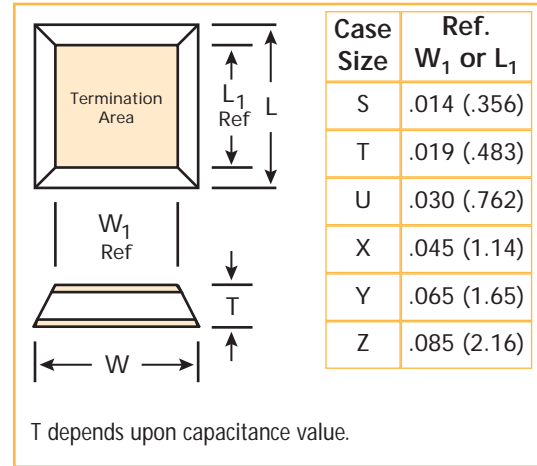

ATC 111 SERIES MILLIMETER WAVELENGTH MICROCAP® – The beveled edges featured in the 111 Series minimize the potential for cracking due to mechanical or thermal shock. The longer path along the beveled edge also provides additional protection against arc-over.

Selection Guide

Case Size	S			T			U			X			Y			Z			
Dimensions (L&W nom.)	.018 (.457) ± .003 (.076)			.025 (.635) ± .005 (.127)			.035 (.889) ± .005 (.127)			.050 (1.27) ± .010 (.254)			.070 (1.78) ± .010 (.254)			.090 (2.29) ± .010 (.254)			
Min. Thickness (T)	.0045 (.114)			.0045 (.114)			.0045 (.114)			.0045 (.114)			.0045 (.114)			.0045 (.114)			
Max. Thickness (T)	.012 (.305)			.012 (.305)			.012 (.305)			.012 (.305)			.012 (.305)			.012 (.305)			
	Capacitance (pF)			Capacitance (pF)			Capacitance (pF)			Capacitance (pF)			Capacitance (pF)			Capacitance (pF)			
	Min.	Max.	Tol.	Min.	Max.	Tol.	Min.	Max.	Tol.	Min.	Max.	Tol.	Min.	Max.	Tol.	Min.	Max.	Tol.	
Dielectric	K																		
A	14	0.1	0.2	A, B	0.2	0.4	A, B	0.4	0.9	A, B, C	0.6	2	B, C	1.3	3.6	B, C	2.4	5.6	B, C
BB	31	0.3	0.4	A, B, C	0.4	1.0	B, C	0.8	1.8	B, C, D	1.3	4.3	C, D	3	8.2	C, D	5.1	13	D, J, K, M
CA	62	0.5	0.9	B, C, D	0.8	2	C, D	1.5	3.9	C, D	2.7	9.1	D, J, K, M	6.2	16	D, J, K, M	10	24	G, J, K, M
CC	130	0.9	2.0	C, D	1.5	4.3	D, K, M	3.3	8.2	D, J, K, M	5.6	18	J, K, M	12	33	J, K, M	22	56	G, J, K, M
DA	165	1.2	2.4	C, D	2.0	5.6	D, K, M	4.3	10	D, J, K, M	7.5	24	J, K, M	15	43	J, K, M	27	68	G, J, K, M
DB	200	1.5	3.0	D, K, M	2.4	6.8	D, K, M	5.1	12	J, K, M	9.1	30	J, K, M	20	51	J, K, M	33	82	G, J, K, M
HC	420	2.4	5.6	K, M	4.3	12	K, M	9.1	22	J, K, M	15	47	J, K, M	33	91	J, K, M	56	150	G, J, K, M
EA	650	4.7	10	K, M	7.5	22	K, M	16	39	J, K, M	27	91	J, K, M	62	160	J, K, M	110	270	G, J, K, M
EC	650	4.7	10	K, M	7.5	22	K, M	16	39	J, K, M	27	91	J, K, M	62	160	J, K, M	110	270	G, J, K, M
J	1100	7.5	15	K, M	15	36	K, M	27	68	J, K, M	47	160	J, K, M	100	300	J, K, M	180	470	J, K, M
F	2000	15	27	K, M	27	68	K, M	51	120	J, K, M	91	300	J, K, M	200	510	J, K, M	330	820	J, K, M
GA	4000	33	68	K, M	56	150	K, M	110	270	J, K, M	200	680	J, K, M	430	1200	J, K, M	750	1800	J, K, M
G	6000	47	91	M	75	180	M	150	360	M	270	820	M	560	1600	M	1000	2400	M
K	9000	62	120	M	110	270	M	220	510	M	390	1200	M	820	2200	M	1500	3300	M
L	16,000	110	220	M	180	510	M	390	910	M	680	2200	M	1500	3900	M	2400	6200	M

Inches (mm)

ATC Part Number Code

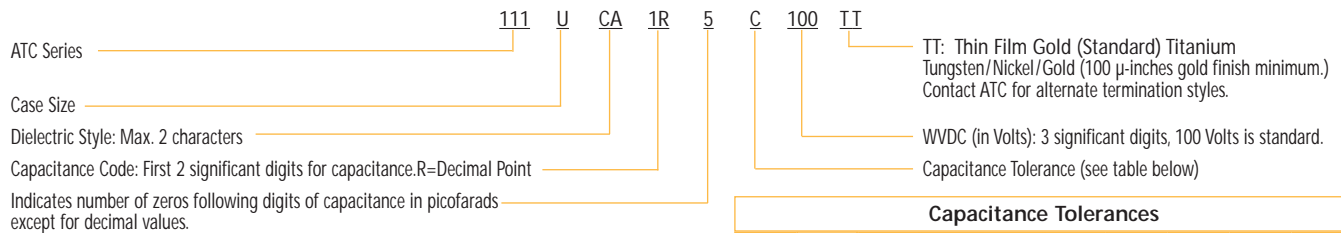

Capacitance Tolerances

Code	A (pF)	B (pF)	C (pF)	D (pF)	F (%)	G (%)	J (%)	K (%)	M (%)
Tol.	± 0.05	± 0.1	± 0.25	± 0.5	± 1	± 2%	± 5	± 10	± 20%

The above part number refers to a 111 series, case size U, CA dielectric, 1.5 pF, with a capacitance tolerance of C (±0.25 pF), 100 WVDC, with thin film gold termination.

ATC accepts orders for our parts using designations with or without the "ATC" prefix. Both methods of defining the part number are equivalent, i.e., part numbers referenced with the "ATC" prefix are interchangeable to parts referenced without the "ATC" prefix. Customers are free to use either in specifying or procuring parts from American Technical Ceramics.

AMERICAN TECHNICAL CERAMICS

ATC North America

ATC Europe

ATC Asia

+1-631-622-4700 • sales@atceramics.com +46 8 6800410 • sales@atceramics-europe.com +86-755-2396-8759 • sales@atceramics-asia.com

ATC 118 SERIES SINGLE SIDED BORDERCAPS™

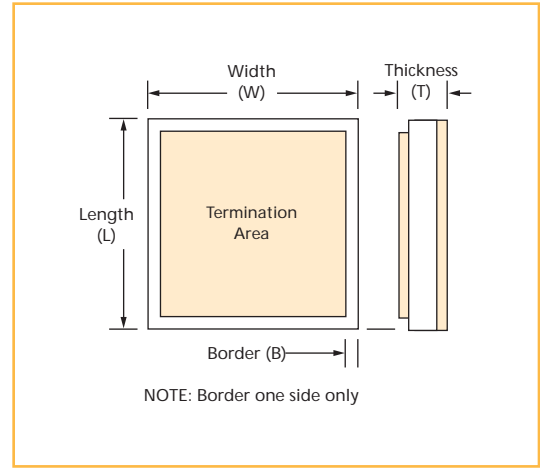

ATC 118 SERIES SINGLE SIDED BORDERCAPS™ – have been designed to minimize potential shorting resulting from epoxy or solder attachments. Contact ATC for further information.

Features:

- Capacitance Range: 0.05 pF to 1800 pF
- Exposed Borders for: Automated Visual Equipment, Solder Resist Area to Reduce Shorts
- Operating Frequency up to 100 GHz

Applications:

- Microwave Integrated Circuits
- Automated MIC Construction
- Chip and Wire Construction
- Matching and Filtering Circuits
- Bypass and Coupling

Selection Guide

Case Size	C			D			E			F			G			H			J			
Width (W) (L&W)	.015 (.381) ±.002 (.0508)			.020 (.508) ±.002 (.0508)			.025 (.635) ±.002 (.0508)			.030 (.762) ±.002 (.0508)			.035 (.899) ±.002 (.0508)			.040 (1.016) ±.002 (.0508)			.050 (1.270) ±.002 (.0508)			
Recessed Metalization Area (L&W)	.011 (.279) +0-.003 (.0762)			.016 (.406) +0-.003 (.0762)			.021 (.533) +0-.003 (.0762)			.026 (.660) +0-.003 (.0762)			.031 (.787) +0-.003 (.0762)			.036 (.914) +0-.003 (.0762)			.046 (1.168) +0-.003 (.0762)			
Min. Thickness (T)	.0045 (.114)			.0045 (.114)			.0045 (.114)			.0045 (.114)			.0045 (.114)			.0045 (.114)			.0045 (.114)			
Max. Thickness (T)	.012 (.305)			.012 (.305)			.012 (.305)			.012 (.305)			.012 (.305)			.012 (.305)			.012 (.305)			
Equivalent Series Capacitance (ESC)	Capacitance (pF)			Capacitance (pF)			Capacitance (pF)			Capacitance (pF)			Capacitance (pF)			Capacitance (pF)			Capacitance (pF)			
	Min.	Max.	Tol.	Min.	Max.	Tol.	Min.	Max.	Tol.	Min.	Max.	Tol.	Min.	Max.	Tol.	Min.	Max.	Tol.	Min.	Max.	Tol.	
Dielectric	K																					
A	14	0.06	0.1	A	0.2	0.2	A, B	0.2	0.3	A, B	0.3	0.4	A, B	0.4	0.6	A, B	0.5	0.9	B, C	0.8	1.3	B, C
BB	31	0.2	0.2	A, B	0.3	0.4	B, C	0.4	0.7	B, C	0.6	1.0	B, C, D	0.8	1.5	C, D	1.1	2.0	C, D	1.8	3.0	C, D
CA	60	0.3	0.4	B, C	0.5	0.8	C, D	0.8	1.3	C, D	1.2	2.0	C, D	1.6	3.0	C, D	2.2	3.9	C, D	3.6	6.2	D, K, M
CC	130	0.6	0.9	C, D	1	1.8	C, D	1.8	3.0	D, M	2.4	4.3	D, K, M	3.6	6.2	D, K, M	4.7	8.2	K, M	7.5	13	K, M
DA	165	0.7	1.2	C, D	1.3	2.2	D	2.2	3.9	D, M	3.3	5.6	D, K, M	4.3	7.5	K, M	5.6	10	K, M	9.1	16	K, M
DB	200	0.9	1.3	D, M	1.5	2.7	D, M	2.7	4.7	M	3.9	6.8	K, M	5.1	9.1	K, M	6.8	13	K, M	11	20	K, M
HC	420	1.5	2.4	D, M	2.7	4.7	M	4.7	8.2	M	6.8	12	K, M	9.1	16	K, M	12	22	K, M	20	36	K, M
EA	650	2.7	4.7	M	4.7	9.1	M	8.2	15	M	12	22	K, M	18	30	K, M	22	39	K, M	36	62	K, M
EC	650	2.7	4.7	M	4.7	9.1	M	8.2	15	M	12	22	K, M	18	30	K, M	22	39	K, M	36	62	K, M
J	1100	4.7	7.5	M	8.2	15	M	15	24	M	22	36	K, M	30	51	K, M	39	68	K, M	62	110	K, M
F	2000	9.1	13	M	16	27	M	27	47	M	39	68	K, M	51	91	K, M	68	120	K, M	110	200	K, M
GA	4000	20	33	M	36	62	M	56	100	M	91	150	K, M	120	200	K, M	160	270	K, M	270	430	K, M
G	6000	27	43	M	47	82	M	75	130	M	120	200	M	160	270	M	220	360	M	330	620	M
K	9000	39	56	M	68	110	M	120	180	M	180	270	M	240	390	M	330	510	M	510	820	M
L	16,000	68	100	M	120	180	M	200	300	M	300	470	M	390	620	M	510	820	M	820	1800	M

Border Dimensions (See B in drawing above): .001 (.0254) min. for case sizes C through J

Inches (mm)

ATC Part Number Code

ATC Series 118 Dielectric Style: Max. 2 characters H Capacitance Code: First 2 significant digits for capacitance. R=Decimal Point A Indicates number of zeros following digits of capacitance in picofarads except for decimal values. OR WVDC (in Volts): 3 significant digits, 100 Volts is standard. 5 Capacitance Tolerance (see table below) B TT: Thin Film Gold (Standard) Titanium Tungsten/Nickel/Gold (100 μ-inches gold finish minimum.) 100 TT

Capacitance Tolerances									
Code	A (pF)	B (pF)	C (pF)	D (pF)	F (%)	G (%)	J (%)	K (%)	M (%)
Tol.	± 0.05	± 0.1	± 0.25	± 0.5	± 1	± 2%	± 5	± 10	± 20%

The above part number refers to a 118 series, case size H, A dielectric, 0.5 pF, with a capacitance tolerance of B (±0.1 pF), 100 WVDC, with thin film gold termination. ATC accepts orders for our parts using designations with or without the "ATC" prefix. Both methods of defining the part number are equivalent, i.e., part numbers referenced with the "ATC" prefix are interchangeable to parts referenced without the "ATC" prefix. Customers are free to use either in specifying or procuring parts from American Technical Ceramics.

AMERICAN TECHNICAL CERAMICS

ATC North America ATC Europe ATC Asia
 +1-631-622-4700 • sales@atceramics.com +46 8 6800410 • sales@atceramics-europe.com +86-755-2396-8759 • sales@atceramics-asia.com

ATC 113 SERIES TWIN CAP® SLCs

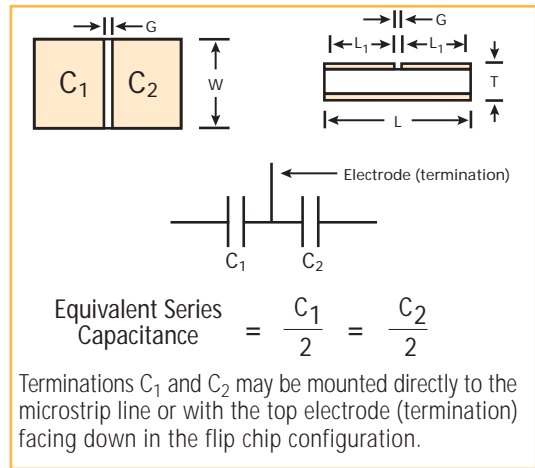

The unique configuration of the ATC 113 Series Twin Cap® provides a wide range of capacitance values with a 100 WVDC rating in a low profile package. The low insertion loss and extremely high self-resonant frequencies of the 113 Series make it ideal for RF / microwave and millimeter wave applications.

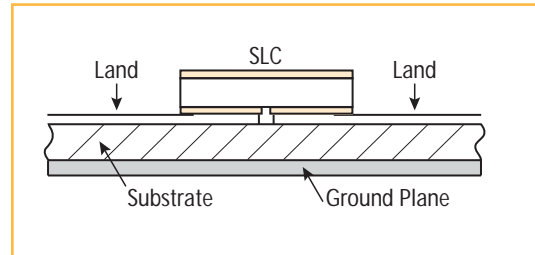

Selection Guide

Case Size	C			D			E			F			G			H			J			
Width (W)	.015 (.381) +0 -.003 (.076)			.020 (.500) +0 -.003 (.076)			.025 (.635) +0 -.003 (.076)			.030 (.762) +0 -.003 (.076)			.035 ± .005 (.899 ± .130)			.040 ± .005 (1.016 ± .130)			.050 ± .005 (1.27 ± .130)			
Length (L)	.040 (1.016) max.			.050 (1.270) max.			.080 (2.032) max.			.080 (2.032) max.			.080 (2.032) max.			.080 (2.032) max.			.080 (2.032) max.			
Gap Width (G)	.008 (.203)			.008 (.203)			.020 (.508)			.020 (.508)			.020 (.508)			.020 (.508)			.020 (.508)			
Min. Thickness (T)	.005 (.127)			.005 (.127)			.005 (.127)			.006 (.152)			.006 (.152)			.006 (.152)			.006 (.152)			
Max. Thickness (T)	.010 (.254)			.010 (.254)			.010 (.254)			.012 (.300)			.012 (.300)			.012 (.300)			.012 (.300)			
Equivalent Series Capacitance (ESC)	Capacitance (pF) Min. Max. Tol.			Capacitance (pF) Min. Max. Tol.			Capacitance (pF) Min. Max. Tol.			Capacitance (pF) Min. Max. Tol.			Capacitance (pF) Min. Max. Tol.			Capacitance (pF) Min. Max. Tol.			Capacitance (pF) Min. Max. Tol.			
Dielectric K																						
A	14	—	—	—	0.05	0.08	B, C	0.08	0.1	B, C	0.08	0.1	B	0.1	0.2	B	0.1	0.2	B	0.2	0.2	B
BB	31	0.05	0.1	B, C	0.1	0.1	B, C	0.2	0.2	B, C	0.2	0.3	B	0.3	0.4	B	0.3	0.5	B	0.3	0.6	B
CA	62	0.2	0.2	B, C	0.2	0.3	B, C	0.4	0.6	B, C	0.4	0.6	B	0.5	0.8	B	0.6	1.0	C	0.8	1.2	C
CC	130	0.3	0.4	B, C	0.4	0.8	C, D	0.8	1.5	C, D	0.8	1.5	C	1.0	1.8	C	1.2	2.2	C, D	1.5	3.0	D
DB	200	0.5	0.6	C, D	1.0	1.2	C, D	1.8	2.2	D	1.8	2.2	D	2.2	3.3	D	2.7	3.6	D	3.3	4.7	D
HC	420	0.8	1.2	C, D	1.5	2.2	D	2.7	4.7	M	2.7	4.7	M	3.6	5.6	M	3.9	6.8	M	5.1	8.2	K, M
EA	650	1.5	1.8	C, D	2.7	3.9	M	5.1	6.8	M	5.1	6.8	M	6.8	10	M	8.2	12	M	10	15	K, M
EC	650	1.5	1.8	C, D	2.7	3.9	M	5.1	6.8	M	5.1	6.8	M	6.8	10	M	8.2	12	M	10	15	K, M
J	1100	2.2	3.3	M	4.7	6.8	M	8.2	12	M	8.2	12	M	12	15	M	15	18	M	18	22	M
F	2000	3.6	6.8	M	8.2	12	M	15	22	M	15	22	M	18	30	M	20	33	M	27	39	M
GA	4000	8.2	12	M	15	27	M	27	51	M	27	51	M	33	68	M	39	82	M	47	100	M
G	6000	15	18	M	30	39	M	56	62	M	56	68	M	68	82	M	100	120	M	120	130	M

Inches (mm)

ATC Part Number Code

ATC Series: 113
 Case Size: D
 Dielectric Style: Max. 2 characters: DB
 Capacitance Code: First 2 significant digits for capacitance. R=Decimal Point: 1R
 Indicates number of zeros following digits of capacitance in picofarads except for decimal values: 0

TT: Thin Film Gold (Standard) Titanium Tungsten/Nickel/Gold (100 μ-inches gold finish minimum.)
 WVDC (in Volts): 3 significant digits, 100 Volts is standard.
 Capacitance Tolerance (see table below, left)

Capacitance Tolerances									
Code	A (pF)	B (pF)	C (pF)	D (pF)	F (%)	G (%)	J (%)	K (%)	M (%)
Tol.	± 0.05	± 0.1	± 0.25	± 0.5	± 1	± 2%	± 5	± 10	± 20%

The above part number refers to a 113 series, case size D, DB dielectric, 1.0 pF, with a capacitance tolerance of D (±0.5 pF), 100 WVDC, with thin film gold termination. ATC accepts orders for our parts using designations with or without the "ATC" prefix. Both methods of defining the part number are equivalent, i.e., part numbers referenced with the "ATC" prefix are interchangeable to parts referenced without the "ATC" prefix. Customers are free to use either in specifying or procuring parts from American Technical Ceramics.

AMERICAN TECHNICAL CERAMICS

ATC North America

+1-631-622-4700 • sales@atceramics.com

ATC Europe

+46 8 6800410 • sales@atceramics-europe.com

ATC Asia

+86-755-2396-8759 • sales@atceramics-asia.com

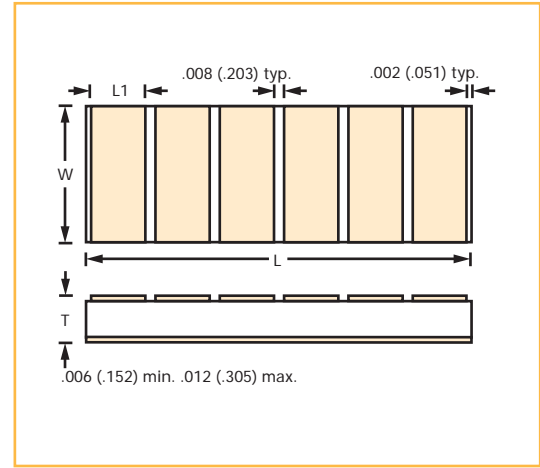

ATC 117 SERIES MULTICAPS™ are ideal for circuits such as MMIC devices requiring multiple capacitance applications, i.e., bypassing and bias circuits. The 117 Multicaps in the Selection Guide below are listed using ATC's GA and K dielectrics, with a pad length of .015 (.380). However, ATC will build Multicaps to customer specifications, up to .050 (1.27) pad length, using any dielectric offered in this catalog. Please consult factory.

Selection Guide

Style	Total Width (W) ± .003 (.076)	Total Length (L) ± .005 (.127)	W x L Per Pad	Cap. Value (pF) Per Pad		Number of Pads	Part Number "GA"	Part Number "K"
				GA	K			
CC	.015 (.381)	.065 (1.65)	.015 (.381) x .015 (.381)	33	70	3	117CC3GA990MTT	117CC3K211MTT
DC	.020 (.508)	.065 (1.65)	.020 (.508) x .015 (.381)	40	90	3	117DC3GA121MTT	117DC3K271MTT
EC	.025 (.635)	.065 (1.65)	.025 (.635) x .015 (.381)	50	110	3	117EC3GA151MTT	117EC3K331MTT
EC	.025 (.635)	.090 (2.29)	.025 (.635) x .015 (.381)	50	110	4	117EC4GA201MTT	117EC4K441MTT
FC	.030 (.762)	.065 (1.65)	.030 (.762) x .015 (.381)	60	130	3	117FC3GA181MTT	117FC3K391MTT
FC	.030 (.762)	.090 (2.29)	.030 (.762) x .015 (.381)	60	130	4	117FC4GA241MTT	117FC4K521MTT
GC	.035 (.889)	.065 (1.65)	.035 (.889) x .015 (.381)	80	140	3	117GC3GA241MTT	117GC3K421MTT
GC	.035 (.889)	.090 (2.29)	.035 (.889) x .015 (.381)	80	140	4	117GC4GA321MTT	117GC4K561MTT
GC	.035 (.889)	.135 (3.43)	.035 (.889) x .015 (.381)	80	140	6	117GC6GA481MTT	117GC6K841MTT
HC	.040 (1.02)	.065 (1.65)	.040 (1.02) x .015 (.381)	90	150	3	117HC3GA271MTT	117HC3K451MTT
HC	.040 (1.02)	.090 (2.29)	.040 (1.02) x .015 (.381)	90	150	4	117HC4GA361MTT	117HC4K601MTT
HC	.040 (1.02)	.135 (3.43)	.040 (1.02) x .015 (.381)	90	150	6	117HC6GA541MTT	117HC6K901MTT
IC	.045 (1.14)	.065 (1.65)	.045 (1.14) x .015 (.381)	100	200	3	117IC3GA301MTT	117IC3K601MTT
IC	.045 (1.14)	.090 (2.29)	.045 (1.14) x .015 (.381)	100	200	4	117IC4GA401MTT	117IC4K801MTT
IC	.045 (1.14)	.135 (3.43)	.045 (1.14) x .015 (.381)	100	200	6	117IC6GA601MTT	117IC6K122MTT
JC	.050 (1.27)	.065 (1.65)	.050 (1.27) x .015 (.381)	110	220	3	117JC3GA331MTT	117JC3K661MTT
JC	.050 (1.27)	.090 (2.29)	.050 (1.27) x .015 (.381)	110	220	4	117JC4GA441MTT	117JC4K881MTT
JC	.050 (1.27)	.135 (3.43)	.050 (1.27) x .015 (.381)	110	220	6	117JC6GA661MTT	117JC6K132MTT

Thickness (T): .006 (0.15) min.; .012 (0.30) max.
Gap between pads: .008 (.203) typical.

Note: Other sizes and configurations are available using any dielectric in this catalog.

ATC Part Number Code

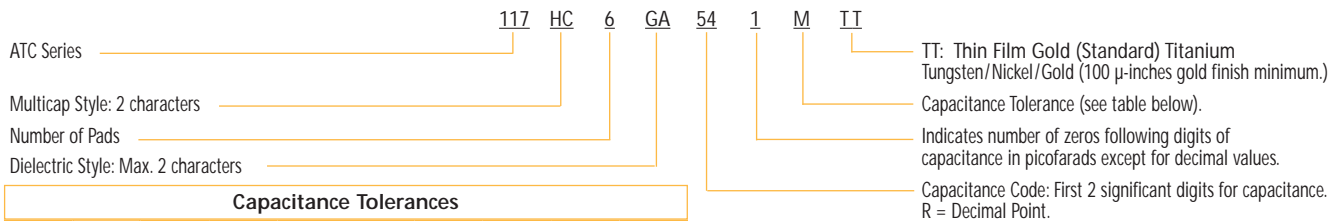

Capacitance Tolerances

Code	A (pF)	B (pF)	C (pF)	D (pF)	F (%)	G (%)	J (%)	K (%)	M (%)
Tol.	± 0.05	± 0.1	± 0.25	± 0.5	± 1	± 2%	± 5	± 10	± 20%

NOTE: Working Voltage = 100 WVDC

The above part number refers to a 117 Series, style HC, 6 pad Multicap, GA dielectric, 540 pF, with a capacitance tolerance of M (± 20%), with thin film gold termination.

ATC accepts orders for our parts using designations with or without the "ATC" prefix. Both methods of defining the part number are equivalent, i.e., part numbers referenced with the "ATC" prefix are interchangeable to parts referenced without the "ATC" prefix. Customers are free to use either in specifying or procuring parts from American Technical Ceramics.

NEW SLC Custom Design Kits - Call +1-631-622-4700 to Order

Kit #	Item#	Description	Cap. Value Range (pF)	Price
Kit 6100	DK6100	116 Series Microcaps® 100 piece total, 10 values, 10 pieces per value	0.1 to 1000 pF	\$120.00
Kit 6150	DK6150	116 Series Microcaps® 150 piece total, 15 values, 10 pieces per value	0.1 to 1000 pF	\$170.00

ATC's SLC Custom Design Kits are based on the Quik Pick Selection Guide below. Select values from this list to build your custom Kit. For KIT 6100, select 10 different values from the Quik Pick List. You will receive 10 pieces of each value (total 100 pieces). For KIT 6150, select 15 values from the list. You will receive 10 pieces per value (total 150 pieces).

SLC Selection Guide – 3 to 5 Day Shipment

Series / Case Size (L & W)		116 R .015 (.381) nom.	116 T .025 (.635) nom.	116 U .035 (.889) nom.	116 X .050 (1.27) nom.
Cap (pF)	Cap Code	0.1 to 100 pF	0.2 to 330 pF	0.4 to 820 pF	0.8 to 1000 pF
0.1	0R1	116RA0R1A100TT			
0.2	0R2	116RBB0R2A100TT	116TA0R2A100TT		
0.3	0R3	116RBB0R3A100TT	116TA0R3A100TT		
0.4	0R4	116RCA0R4B100TT	116TA0R4A100TT	116UA0R4A100TT	
0.5	0R5	116RCA0R5B100TT	116TBB0R5A100TT	116UA0R5A100TT	
0.8	0R8	116RDB0R8B100TT	116TBB0R8B100TT	116UBB0R8A100TT	116XA0R8A100TT
1.0	1R0	116RDB1R0C100TT	116TCA1R0B100TT	116UBB1R0B100TT	116XA1R0A100TT
1.2	1R2	116RDB1R2C100TT	116TCA1R2B100TT	116UBB1R2B100TT	116XA1R2A100TT
2.7	2R7	116REA2R7M100TT	116TDB2R7C100TT	116UCA2R7C100TT	116XBB2R7C100TT
3.0	3R0	116REA3R0M100TT	116TDB3R0C100TT	116UCA3R0C100TT	116XBB3R0C100TT
3.6	3R6	116REA3R6M100TT	116TDB3R6D100TT	116UCA3R6D100TT	116XCA3R6C100TT
5.1	5R1	116REA5R1M100TT	116TDB5R1D100TT	116UDB5R1D100TT	116XCA5R1C100TT
10	100	116RF100M100TT	116TEA100K100TT	116UDB100K100TT	116XDB100J100TT
15	150	116RF150M100TT	116TEA150K100TT	116UEA150K100TT	116XDB150J100TT
22	220	116RGA220M100TT	116TEA220K100TT	116UEA220K100TT	116XDB220K100TT
27	270	116RGA270M100TT	116TF270K100TT	116UEA270K100TT	116XDB270K100TT
33	330	116RGA330M100TT	116TF330K100TT	116UEA330K100TT	116XEA330K100TT
47	470	116RG470M100TT	116TF470K100TT	116UF470K100TT	116XEA470K100TT
56	560	116RG560M100TT	116TF560K100TT	116UF560K100TT	116XEA560K100TT
68	680	116RK680M100TT	116TGA680K100TT	116UF680K100TT	116XEA680K100TT
82	820	116RK820M100TT	116TGA820K100TT	116UF820K100TT	116XEA820K100TT
100	101	116RL101M100TT	116TGA101K100TT	116UF101K100TT	116XF101K100TT
220	221		116TK221M100TT	116UG221M100TT	116XF221K100TT
330	331		116TL331M100TT	116UK331M100TT	116XGA331K100TT
470	471			116UK471M100TT	116XGA471K100TT
560	561			116UL561M100TT	116XG561M100TT
680	681			116UL681M100TT	116XK681M100TT
820	821			116UL821M100TT	116XK821M100TT
1000	102				116XK102M100TT

Inches (mm)

ATC Part Number Code

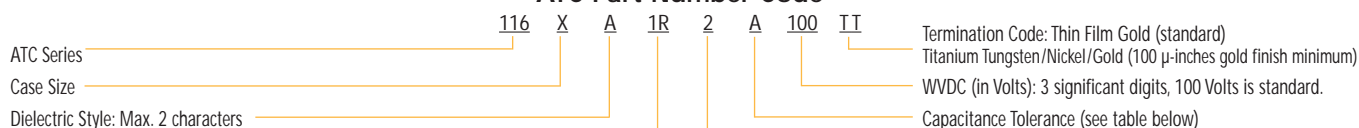

Capacitance Tolerances

Code	A (pF)	B (pF)	C (pF)	D (pF)	F (%)	G (%)	J (%)	K (%)	M (%)
Tol.	± 0.05	± 0.1	± 0.25	± 0.5	± 1	± 2%	± 5	± 10	± 20%

The above part number refers to a 116 series, case size X, A dielectric, 1.2 pF, with a capacitance tolerance of A (±0.05pF), 100 WVDC, with thin film gold termination.

ATC accepts orders for our parts using designations with or without the "ATC" prefix. Both methods of defining the part number are equivalent, i.e., part numbers referenced with the "ATC" prefix are interchangeable to parts referenced without the "ATC" prefix. Customers are free to use either in specifying or procuring parts from American Technical Ceramics.



**Commercial Off The Shelf
High Reliability Certification Program**

The ATC COTS Program provides a cost efficient approach to qualifying standard products for enhanced reliability applications. This flexible program offers standard screening packages with options to support specifics of customer-driven program requirements.

Applications:

- Ruggedized Commercial
(Medical, Industrial, Telecommunications)
- Military
(Ground, Naval, Airborne)
- Space/Satellite

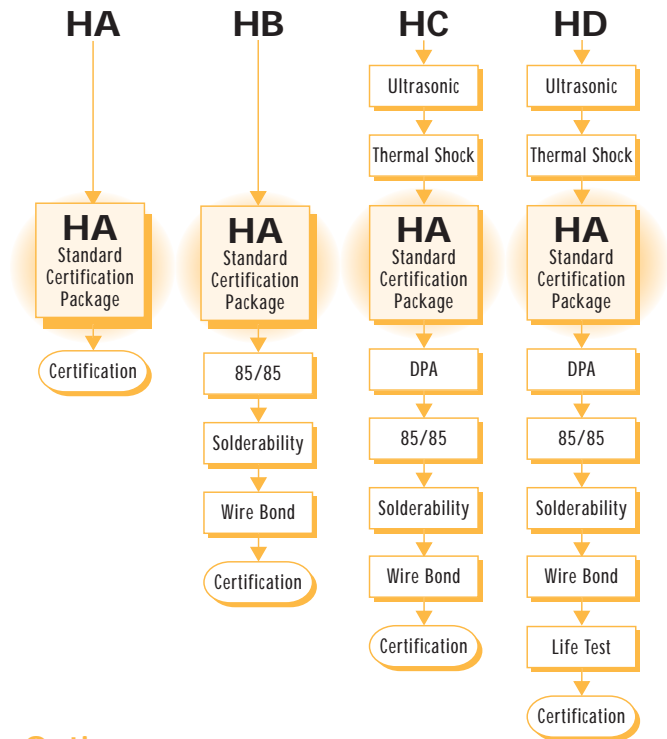

ATC COTS Screening Options

HD: Highest Screening Level
The highest screening option adds life testing as an assurance in mission critical applications and is often used as an alternative in space qualified applications.

HC: Airborne Applications
Often used in airborne applications, this profile closely models the military specifications.

HB: Additional Sample Testing
Built upon our standard HA Screening, this program provides additional sample testing to certify the termination for attachment integrity and the ability to survive and perform in high humidity environments.

HA: Standard Upscreen Package
ATC's Standard Hi Rel certification screening profile is typically used as a lower cost means to certify product reliability. HA screening is used throughout the industry in ground based military applications as well as stringent commercial applications.

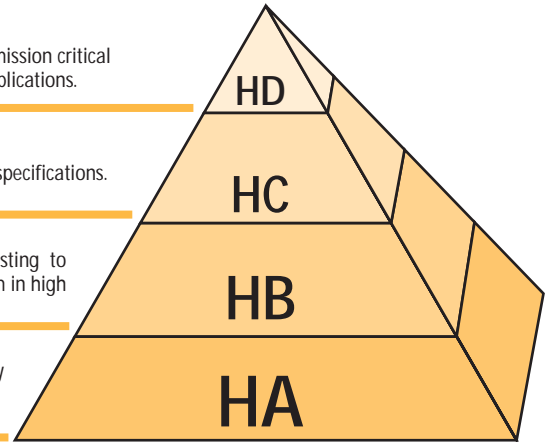

P/N Prefix				Evaluation Operation	Sample Size
HA	HB	HC	HD		
		X	X	Ultrasonic Screening	100%
		X	X	Thermal Shock (5 Cycles for HC and 20 Cycles for HD)	100%
X	X	X	X	Standard Hi-Rel Certification Package (HA)	100%
		X	X	Destructive Physical Analysis	see table*
	X	X	X	85/85 (Low Voltage Moisture Humidity)	13 units*
	X	X	X	Solderability (Solderable or Solder Coated Only)	5 units*
	X	X	X	Wire Bond Test (Gold Terminated Chips Only)	13 units*
			X	Life Test (2000)	25 units*

Lot Size	Sample
1 - 500	14
501 - 10,000	32
10,001 - 35,000	50
35,001 and up	80

* Additional sample units required that have passed the 100% testing along with the deliverable (flight) quantity.

ATC NORTH AMERICA

AMERICAN TECHNICAL CERAMICS

One Norden Lane, Huntington Station, NY 11746-2142
 Phone: +1-631-622-4700 • Fax: +1-631-622-4748
 email: sales@atceramics.com • website: www.atceramics.com

ATC EUROPE

For technical support in your region, please contact the local office in Germany or the UK. For sales orders and all other transactions in Europe, Africa and the Middle East, please contact the ATC Sales, Applications Support and Distribution Center in Stockholm, Sweden.

SALES, APPLICATIONS SUPPORT & DISTRIBUTION CENTER

Serving Europe, Africa and the Middle East
 AMERICAN TECHNICAL CERAMICS AB
 Ellipsvaegen 5
 SE-141 75 Kungens Kurva, Sweden
 Phone: +46 8 6800410 • Fax: +46 8 6800415 (main) • Mobile: +46 805901399
 email: sales@atceramics-europe.com • website: www.atceramics-europe.com

ATC EUROPE - REGIONAL SATELLITE OFFICE, GERMANY

AMERICAN TECHNICAL CERAMICS
 Raiffeisenstrasse 12
 D-83607 Holzkirchen, Germany
 Phone: +49 8024 6083978 • Fax: +49 8024 6083979 Mobile: +49 1515 4106982
 email: twiesner@atceramics-europe.com

ATC EUROPE - REGIONAL SATELLITE OFFICE, RUSSIA

AMERICAN TECHNICAL CERAMICS
 Ellipsvaegen 5
 SE-141 75 Kungens Kurva, Sweden
 Phone: +46 8 6800410 • Fax: +46 8 6800415 (main) • Mobile: +46 805901399
 email: sales@atceramics-europe.com • website: www.atceramics-europe.com

ATC EUROPE - REGIONAL SATELLITE OFFICE, UK

AMERICAN TECHNICAL CERAMICS
 34 Pewley Way
 Guildford, Surrey, England, GU1 3QA
 Phone: +44 1483207402 • Fax: +46 8 6800415 • Mobile: +44 8817221903
 email: mchapman@atceramics-europe.com • website: www.atceramics-europe.com

ATC ASIA / INDIA SALES AND TECHNICAL SUPPORT OFFICE

AMERICAN TECHNICAL CERAMICS (CHINA) LIMITED
 Unit D & E, 11/F JunYun Century Building,
 No. 6033 Chegongmiao, Shennan Road, Futian Dist. Shenzhen,
 Guangdong Province, 518031 P. R. China
 Phone: +86 755 2396 8759 • Fax: +86 755 2396 8442
 e-mail: sales@atceramics-asia.com • website: www.atceramics-asia.com

Sales of ATC products are subject to the terms and conditions contained in American Technical Ceramics Corp. Terms and Conditions of Sale(ATC document #001-992 Rev. B 12/05). Copies of these terms and conditions will be provided upon request. They may also be viewed on ATC's website at www.atceramics.com/productfinder/default.asp. Click on the link for Terms and Conditions of Sale.

ATC has made every effort to have this information as accurate as possible. However, no responsibility is assumed by ATC for its use, nor for any infringements of rights of third parties which may result from its use. ATC reserves the right to revise the content or modify its product without prior notice.

© 2001 American Technical Ceramics Corp. All Rights Reserved.

ATC # 001-857 Rev. O: 7/10

A M E R I C A N T E C H N I C A L C E R A M I C S

ATC North America

ATC Europe

ATC Asia

+1-631-622-4700 • sales@atceramics.com +46 8 6800410 • sales@atceramics-europe.com +86-755-2396-8759 • sales@atceramics-asia.com

w w w . a t c e r a m i c s . c o m

A M E R I C A N T E C H N I C A L C E R A M I C S

ATC North America ATC Europe ATC Asia
+1-631-622-4700 • sales@atceramics.com +46 8 6800410 • sales@atceramics-europe.com +86-755-2396-8759 • sales@atceramics-asia.com

w w w . a t c e r a m i c s . c o m

Other ATC Product Catalogs

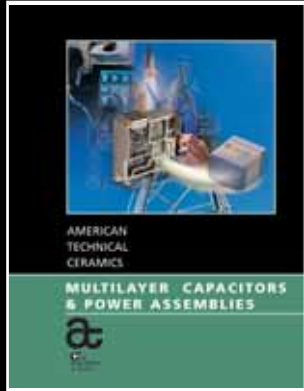

Multilayer Capacitors
& Power Assemblies

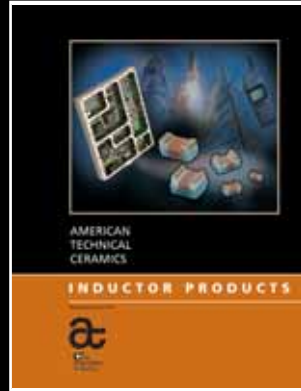

Inductor
Products

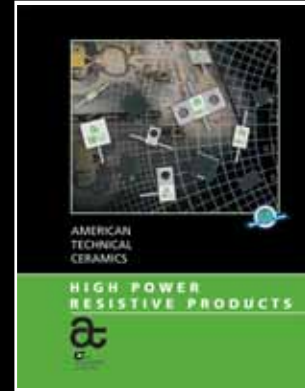

High Power
Resistive Products

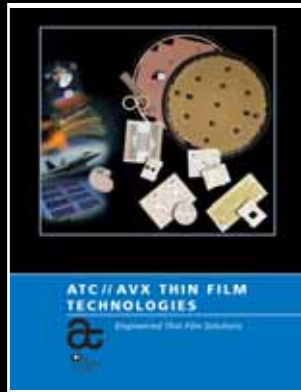

Custom Thin Film
Products



Single Layer
Capacitors

www.atceramics.com



AMERICAN TECHNICAL CERAMICS

ATC North America
+1-631-622-4700
sales@atceramics.com

ATC Europe
+46 8 6800410
sales@atceramics-europe.com

ATC Asia
+86-755-2386-8759
sales@atceramics-asia.com

 THE
ENGINEERS'
CHOICE®
ISO 9001 REGISTERED

www.atceramics.com